

	Length
<p>Ridge Cap</p>	<p>10'6" Pitch?</p>
<p>Hip Ridge Cap</p>	<p>10'6" Pitch?</p>
<p>18" Ridge Cap</p>	<p>10'6" Pitch?</p>
<p>Inside Corner</p>	<p>10'6" 12'6" 14'6" 16'6"</p>
<p>Rake & Corner</p>	<p>10'6" 12'6" 14'6" 16'6"</p>
<p>Offset Rake & Corner</p>	<p>10'6" 16'6"</p>
<p>Residential Rake w/ Kickout</p>	<p>10'6" 16'6"</p>
<p>Residential Rake & Door Edge</p>	<p>10'6"</p>

J-Channel

Length

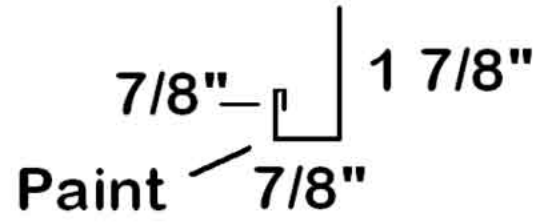

10'6"

Long Back "J"

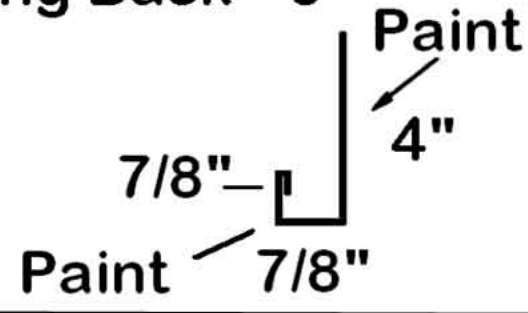

10'6"

Base Angle

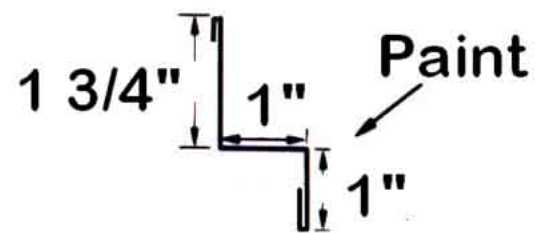

10'6"

Rat Guard

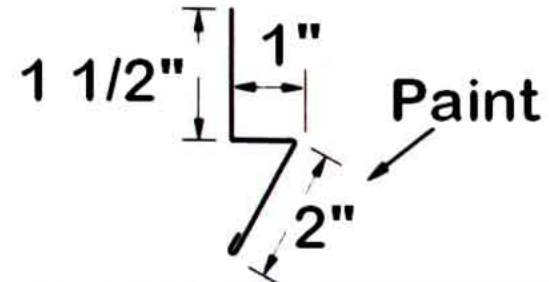

10'6"

Wide Base Angle

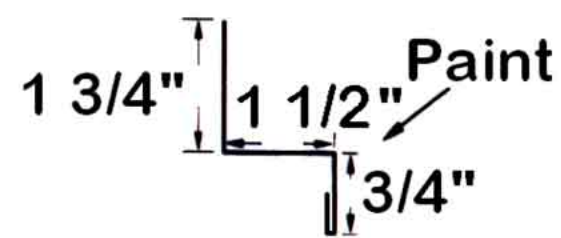

10'6"

Inside Base Angle

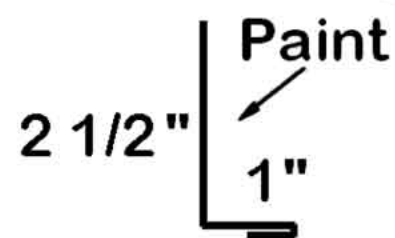

10'6"

Box Base Angle

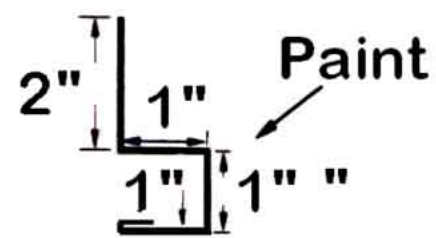

10'6"

Drip Cap

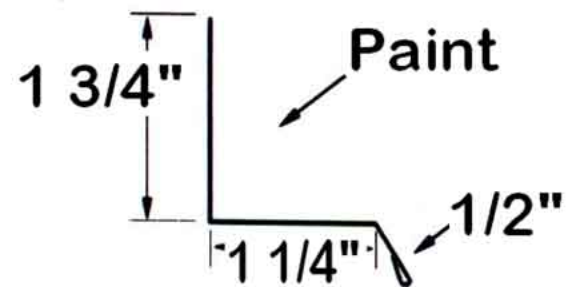

10'6"

Underpinning Top Rail

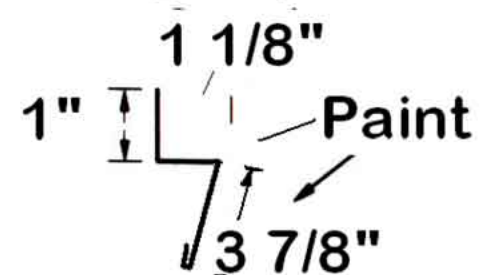

10'6"

Length

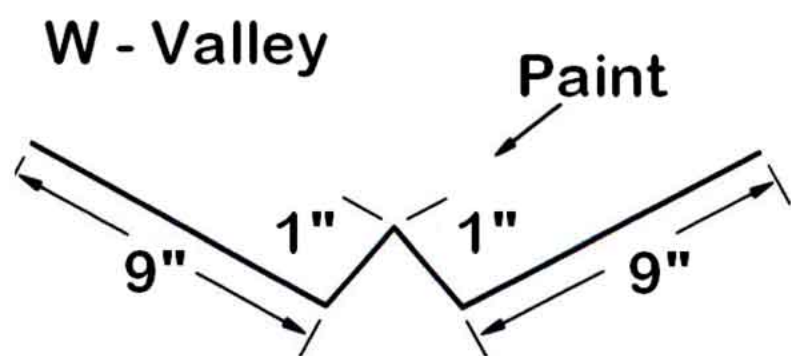

10'6"
Pitch?

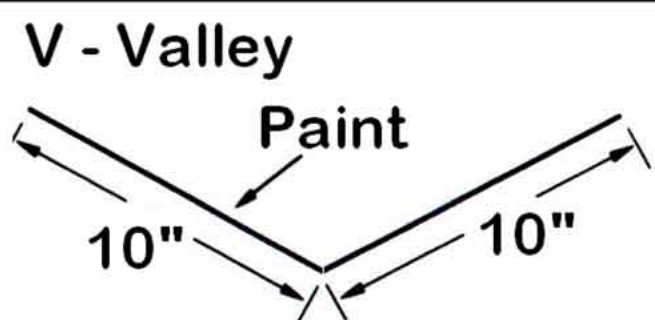

10'6"
Pitch?

Eave Trim 2" / 3"

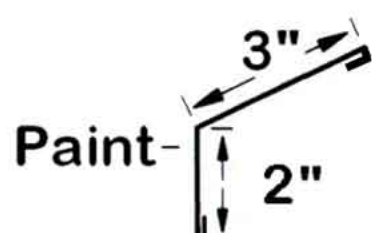

10'6"
Pitch?

Fascia #1

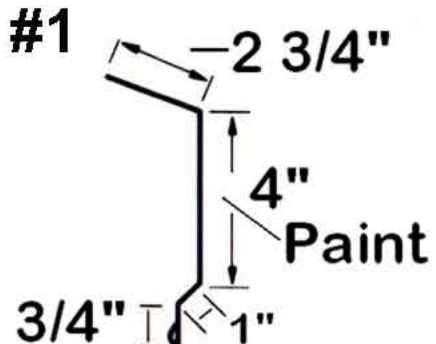

10'6"
Pitch?

Universal Sidewall

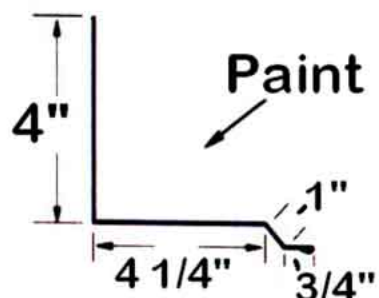

10'6"

Universal Endwall

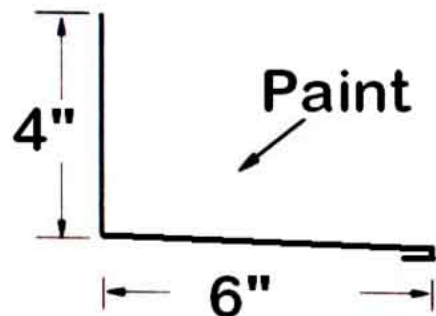

10'6"
Pitch?

Slope Transition

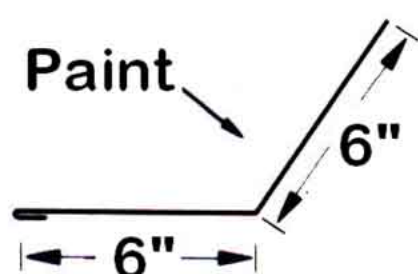

10'6"
Pitch?

F & J Channel

Soffit
or Panel

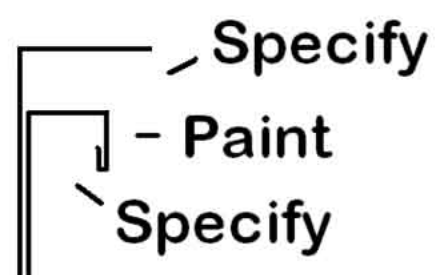

10'6"

F Channel

Soffit
or Panel

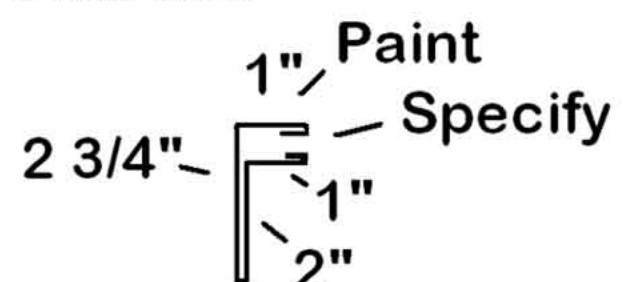

10'6"

Snow Guard

Length

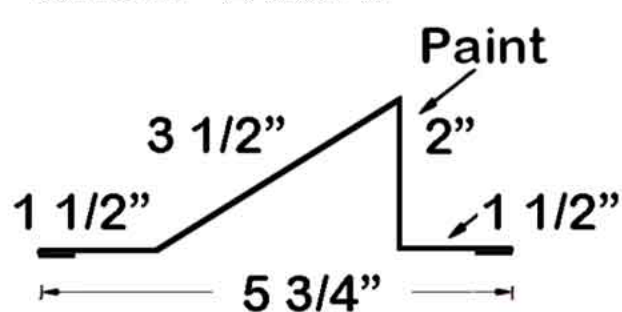

10'6"

Single Track Cover (round)

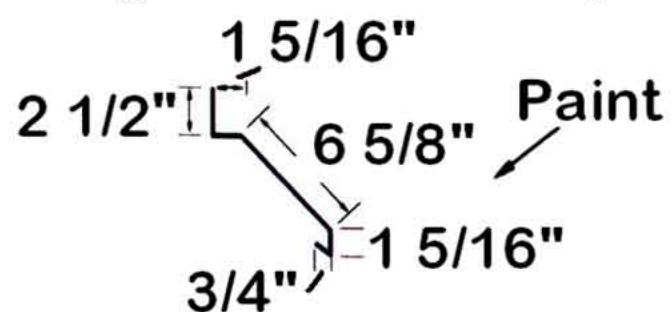

10'6"

Double Track Cover

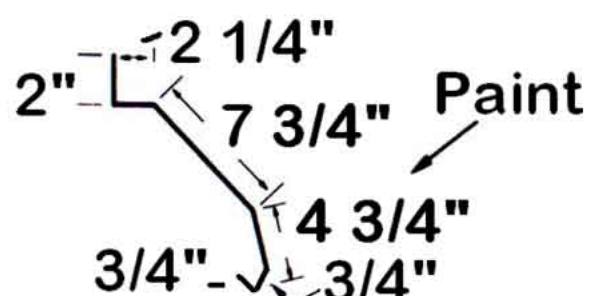

10'6"

Square Track Cover

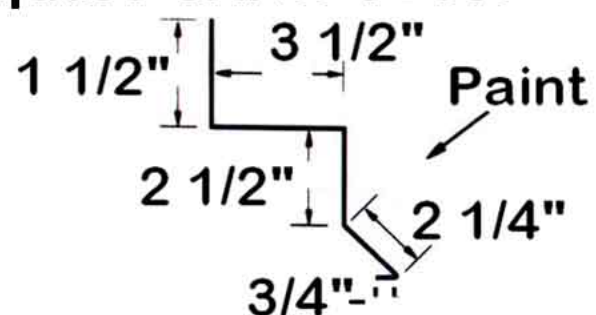

10'6"

Wide Track Cover

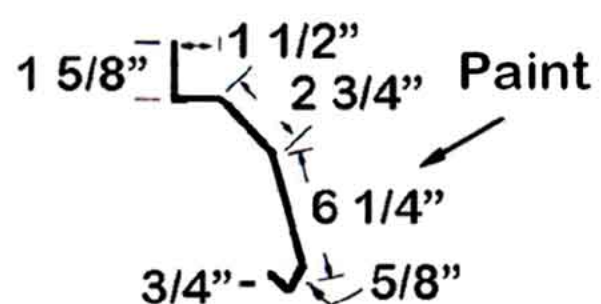

10'6"

Peak Plate

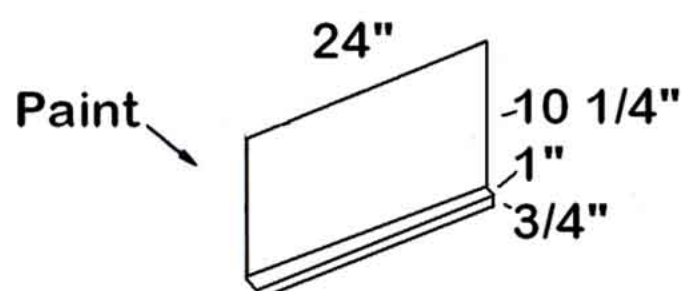

Fascia #2 w/ hem on 1 1/2" leg

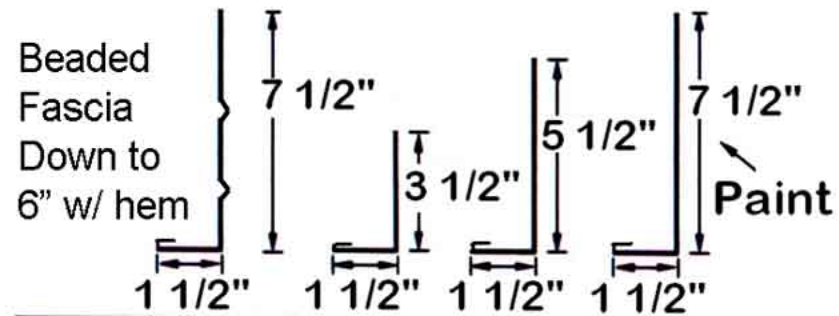

10'6"

Single Angle no hems (outside)

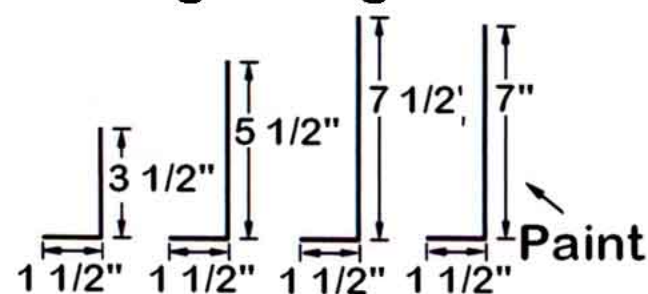

10'6"

**Single Angle w/ hems
Inside (ia) Outside (sa)**

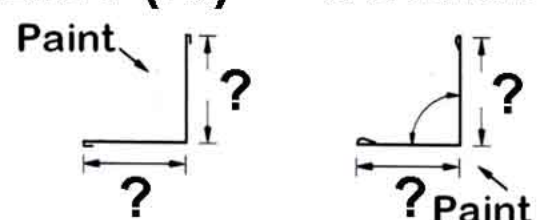

10'6"

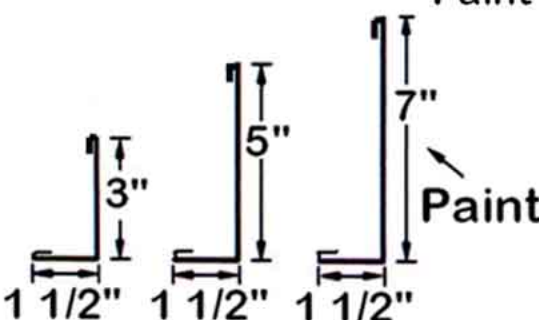

10'6"

Door Post Trim

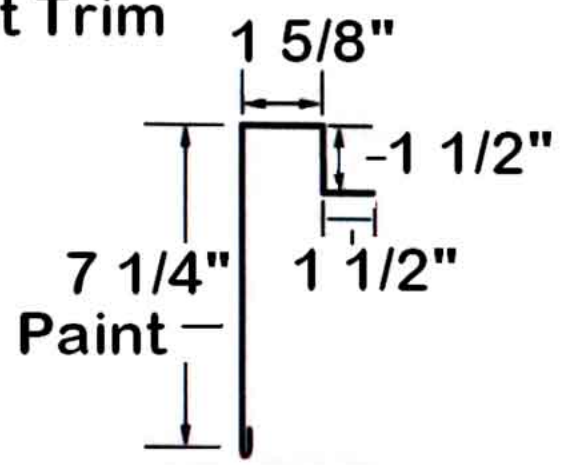

Length

10'6"

Overhead Door Jamb 2-piece

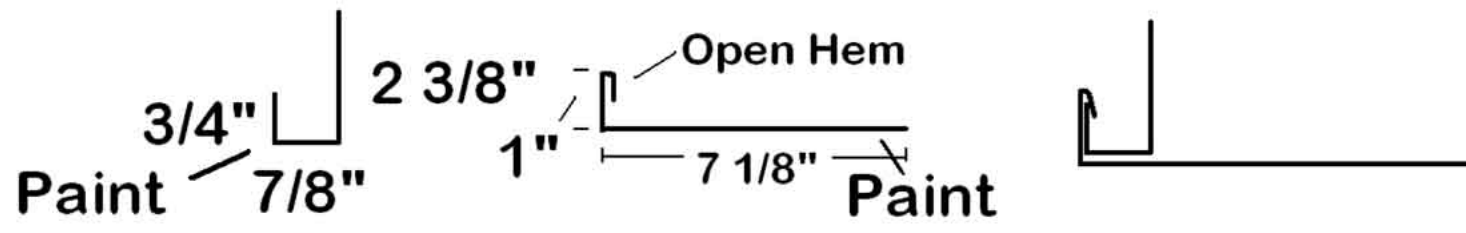

10'6"

